

# Installation Guide

## Terre-Pex

A better approach to energy-efficient, insulated Pipes





Table of Contents

TERRE-PEX

Insulated Pex Pipe .....	4
Insulated Pex Specifications .....	5
Installing in Trenches .....	6
Installing Utility Trenches .....	7-8
Terre-Pex in Buildings .....	9
Terre-Pex Fittings .....	10
Dust & Shrink Caps .....	11
Shrink Wrapping Tape .....	12
Wall Penetration Sleeve .....	13
Pressure Test .....	14

## Terre-Pex Pipe System

A high performance piping system is essential for energy savings. Terre-Pex pre-insulated piping system, composed of a thermal insulation around a carrier pipe and covered by a "closed chamber" jacket, is therefore your best choice.

Terre-Pex piping is suitable for use in both heating and sanitary applications and provides significant advantages.

As the pipes are low-weight and extremely flexible, they can be laid easily and rapidly, even over obstacles and around corners. System accessories can be mounted without any special tools.

Our PEX-a carrier pipe (polyethylene is the raw material and the X refers to the cross-linking of the polyethylene across its molecular chains) is oxygen diffusion-proof in accordance with DIN 4726. It can transport a large number of different liquids and is fully corrosion free.

Terre-Pex is made available as a single and double piping system. It is manufactured free of CFC's. The system is granted approval certificates by various test institutes and monitoring authorities.

## NA Standards Approval

The Terre-Pex line of products delivers complete end-to-end solutions for your insulated piping needs. The system consists of a full set of different diameter pipes with

- NSF/ANSI 14/61 and CSA B 137.5 approved for potable water applications
- Manufactured in accordance with ASTM F 877
- Manufactured in ISO 9001 production facilities

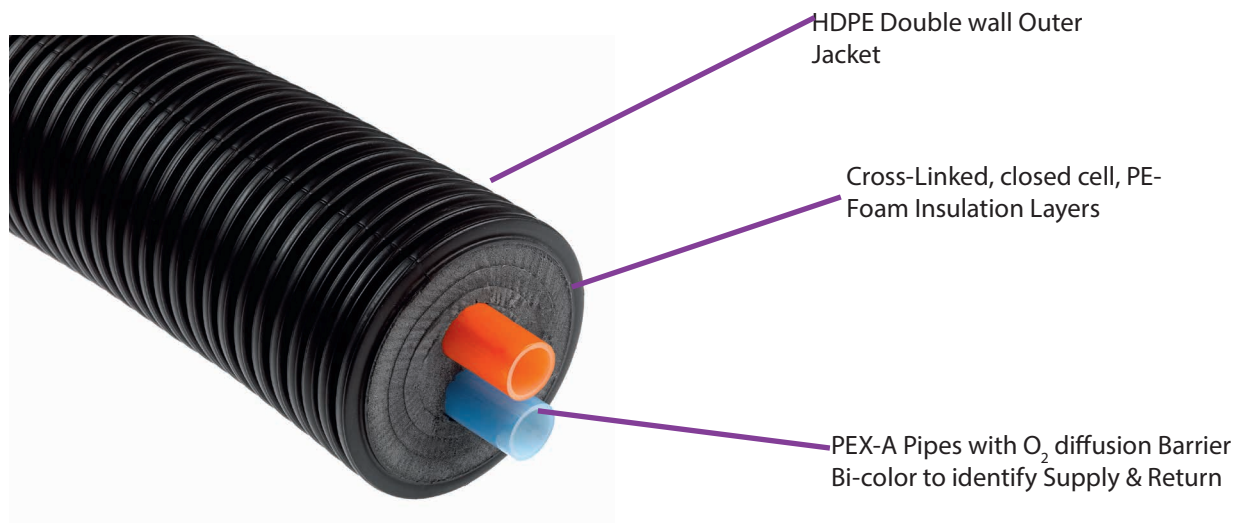

Terre-Pex Insulated Pipes are the ideal solution for delivery of hot and chilled water where the energy preservation is key. Terre-Pex insulated piping provides the highest bending flexibility in the industry and thus minimizes overhead in project related pipe system considerations.

We differentiate Terre-Pex insulated pipes with either single or double carrier pipes for convenient supply and return piping based on project needs.

Terre-Pex insulated pex-A pipe can be delivered in any length required up to full coils of 328 feet. ComfortPro Systems provides a cut-to-length quick ship service for your project's needs. With a wide selection of pipe diameters in stock CPS can provide the right solution for your application requirements.

ComfortPro Systems also offers a full selection of pipe matching brass fittings 1" to 4" (110mm)

**Energy Efficiency of Terre-Pex Pipes (R-Value)**

Insulation Efficiency is commonly referred to as R-value. The tables below show R-Values for Terre-Pex Single and Double pipes.

**Nomenclature Diameters**

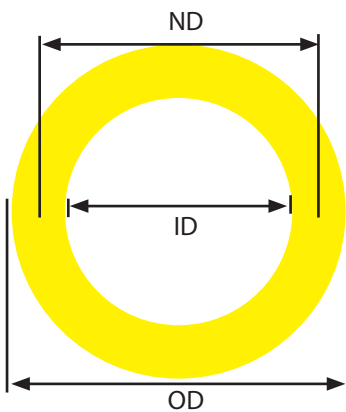

ND = Nominal Diameter  
 ID = Internal Diameter  
 OD = Outer Diameter

**Single Heating Pipes**

Art. No.	Medium pipe		s	ID	Bending radius	water content	Heat capacity	R-value
	Jacket pipe OD	pipe OD						
	in	in	in	in	in	gal/100ft	Btu/hr	Btu/hr /ft / °F
H9032	3.5	1.26	0.11	1.03	9.8	4.34	205	7.064
H14040	5.5	1.57	0.15	1.28	13.8	6.72	307	6.868
H14050	5.5	1.97	0.18	1.61	15.7	10.53	478	6.868
H16063	6.3	2.48	0.23	2.02	21.7	16.71	751	6.434
H16075	6.3	2.95	0.27	2.42	29.5	23.85	1126	5.229
H20090	7.9	3.54	0.32	2.90	43.3	34.27	1638	5.227
H200110	7.9	4.33	0.39	3.54	47.2	51.24	2388	3.889

**Double Heating Pipes**

Art. No.	Medium pipe		s	ID	Bending radius	water content	Heat capacity	R-value
	Jacket pipe OD	pipe OD						
	in	in	in	in	in	gal/100ft	Btu/hr	Btu/hr /ft / °F
HD1401	5.5	0.98	0.09	0.8	13.8	5.26	1.02	7.109
HD14032	5.5	1.26	0.11	1.03	15.7	8.68	205	5.661
HD16040	6.3	1.57	0.15	1.28	23.6	13.45	307	5.468
HD16050	6.3	1.97	0.18	1.61	23.6	21.06	478	3.918
HD20063	7.9	2.48	0.23	2.02	47.2	33.42	751	3.595

4

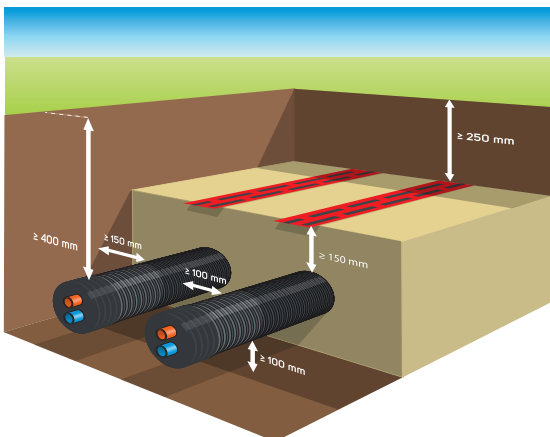

**Quick Installation:**

1. Simply dig a trench (Minimum 24" deep)
2. Place 4" of sand into trench
3. Lay the Terre-Pex pipe in the trench
4. Cover over with fine earth or sand
5. Position warning tape above pipes
6. Connect to appliance or wall outlet, e.g. boiler or heat exchanger
7. Perform leak test
8. Close the trench

No compensation elements needed since the pipe moves inside the HDPE jacket with temperature.

## Transport and Storage of Terre-Pex

Terre-Pex pipelines are supplied in coils with a maximum length of 328 feet. Pipe ends are sealed with protective end caps as to prevent the entry of pollutants.

In storage, care must be taken to ensure that the protruding PEX-a carrier pipe is protected from sunlight and that no undesirable deformation of the coil is being formed.

Pipes must be transported and stored in such a way that sharp objects, stones or other external influences cannot damage them. Pipes must not be dragged along the ground. Only nylon or textile straps should be used for fastening the coils when hoisted or during transport.

## Instructions for laying Terre-Pex pipes in trenches

Terre-Pex pipelines can be laid in earth without difficulties. The corrugated jacket provides the necessary protection for the insulating material and the medium pipe. Groundwater has no influence on the Terre-Pex system. The pipes may be laid into the trench directly from the coil. This may only be done by pulling the carrier pipes (never pull the jacket).

When uncoiling the pipe, please make sure that the pipe is not dragged along the ground nor damaged by sharp objects and that the outside pipe ends don't whip back when untying the textile straps.

The bending radius (see product data sheets) must not fall below the prescribed minimum neither during installation nor in the final position of the pipeline.

Pipes must be laid in a serpentine course and may be covered with sand at regular intervals. General guidelines for laying underground pipes must be followed meticulously.

When laying larger dimensions and lengths, pulling devices such as winches or tail-end rollers may be used. Always connect these devices to the carrier pipe.

The carrier pipe must be fitted with protective end caps preventing the entry of dirty particles.

## Backfilling guidelines

Carefully place the Terre-Pex pipeline on a compacted 4" thick bed of sand on the bottom of the trench. The quality of this sand bed providing uniform support for the pipe line has a decisive influence on the compressive stress of the system. Make sure that the pipes are fully covered with sand (granulometry of 0-1/8").

Backfilling should be in layers of about 8" thick and compacted by hand. Care should be taken to remove any sharp objects from the backfill material. When the backfill has been brought to about 20" above the top of the pipe, a vibrating tamper may be used to compact the remainder of the soil.

There should also be a warning tape bearing the legend water pipe laid directly above the duct.

## Utility Trench Considerations



Up to a trench depth of 4 feet, we recommend digging a vertical trench; deeper than 4 feet, we recommend a V-shaped trench.

Excavation work must be carried out in the approved manner, according to the rules and regulations of local authorities. A prior permission is very often required.

The depth of the trench must be in accordance with the guidelines of the following pages. These guidelines relate to laying of Terre-Pex pipes. A land register plan might be useful to eliminate possible conflicts with existing or future utilities and structures.

After completion of the pipe-laying process, the route can be marked with a warning tape. Entry in the land register plan is recommended.

### Note:

Minimum laying temperature for Terre-Pex pipes is 23°F.

Particular attention must be paid to ground frost depth when laying sanitary pipes. Check with local codes for compliance.

## Laying Terre-Pex Pipes



Orient Terre-Pex Double pipes with the PEX pipes on top of each other rather than side by side if underground branching is planned.

This method makes the assembly of terminal connections in casings much easier.

Note: If Terre-Pex Double pipes are laid in trenches and branching or splitting of the pipes within the trench are planned, care should be taken to orient the pipes for the planned connection requirements.

To facilitate the connection of branch pipes to the main pipes, superposition of the inner medium-carrying PEX-A pipes is recommended (as shown in the drawing).



Always consider the local frost depth to determine the minimum placement depth of the pipes.

To avoid damaging the outer protective HDPE jacket, always lay the pipes in a sand bed. Back-fill only after fully covering the pipes with sand, respecting the minimal layer dimensions as indicated in the drawing.

Warning tape or warning mesh positioned above the buried pipes should avoid damaging these pipes when carrying out ground works at a later stage.

For a state-of-the-art installation, the following guidelines should be respected. Failing to do so involves a genuine damage risk, and automatically voids the system warranty.



- The installation of adequately anchored Fix Points at the system's extremities (typical at wall penetrations) is mandatory. This to secure the connected plumbing against the potential impact of the system's dilatation forces (thermal expansion/retraction).

- All underground pipe connections should be executed with purpose designed PE-X couplings.

- To prevent ingress of (ground)water, the EN 15632-3 standard prescribes the usage of Shrink End Caps to seal the non-bonded system layers at underground connections.



- Prior to concealing, the methodical execution and documentation of the standardised Pressure Test of the entire system is required to determine the integrity of the underground plumbing.

To avoid potential contamination during transportation and handling, our pre-insulated pipes are always delivered with the medium-carrying pipes closed with plastic plugs and dust caps. All pipe systems intended for potable (drinking) water and other sanitary domestic tasks, such as washing and showering applications, should always be thoroughly rinsed before commissioning, following the locally applicable hygienic regulations and accepted practice

## Instructions for wall and Ceiling Installation

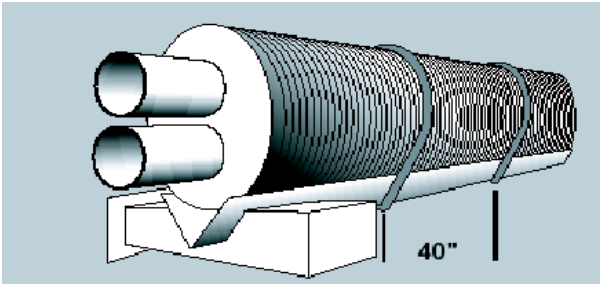

For this purpose, the pipe must be supported every 40" along its entire length because of the flexibility. To avoid bending, the pipe must be tied with straps to a supporting structure every 40".

## Instructions for above ground installation

If the pipeline is laid on the ground, points of support must be provided to prevent slipping away. On bumpy ground, the pipe should be tied at intervals of about 82" spaced apart at equal distances and care must be taken to ensure that the pipes are well supported. For this purpose a supporting structure can be set up.

Terre-Pex pipes must be protected against direct UV radiation.

## Securing the pipe

### In a trench:

Care must be taken to ensure that a serpentine line is maintained. In order to keep the pipes in the desired position, the trench may be backfilled with sand at regular intervals.

### In buildings:

Fixed point brackets have to be installed, ideally at entry of buildings. Such brackets fixed onto the carrier pipes intercept their contraction and expansion.

A minor insulation retreat is a common phenomenon.

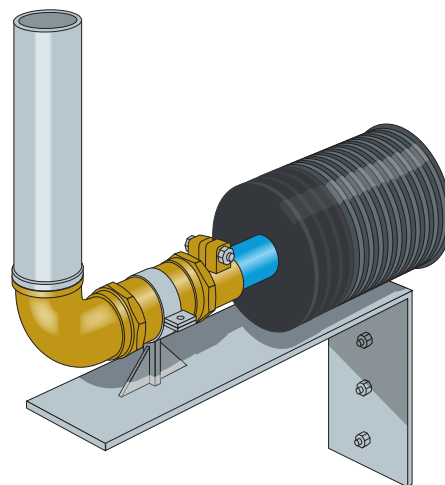



Terre-Pex Pex couplings are professional fittings for central heating, sanitary and industrial installations. They are available in straight versions with male threads for all Terre-Pex sizes

Max. operating pressure of 84 psi. for central heating applications in the range of 1" to 4" and max. operating pressure of 140 psi. for sanitary in the range of 1" to 2-1/2" Jentro can be combined with brass accessories to make tees and elbow couplings, connecting pieces, etc.

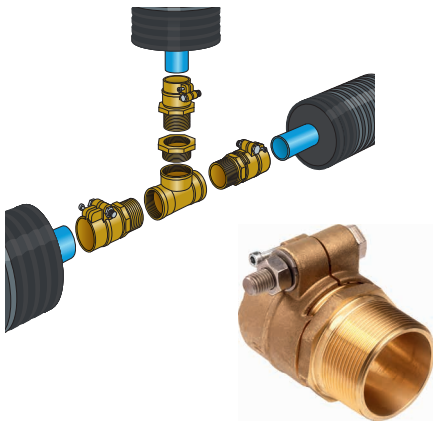

Remove and loosen clamp and slide clamp on to the pipe

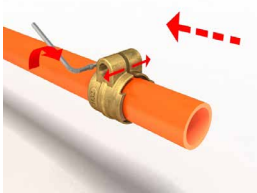

Push the pipe over the coupling's barbed section.

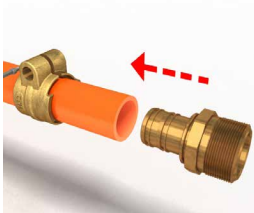

Slide the clamp ring back to completely cover the fitting

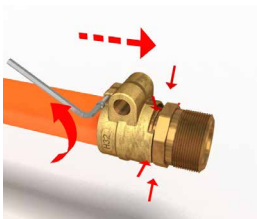

Assemble the tightening bolt, washer and nut provided within the package and tighten the clamping nut.

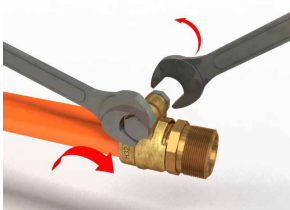

## Dust Caps



Dust Caps are being used to prevent penetration of dirt and rodent into the pipe insulation when Terre-Pex pipes are being layed above ground and/or in buildings.

Dust Caps do not prevent water or other liquids from entering Terre-Pex pipe insulations and are thus not recommended to be used instead of shrink caps in wet and/or strongly humid environments.

Dust caps are easily pushed over the end of a Terre-Pex pipe.

## Shrink Caps



Shrink Caps provide an easy and essential way of protecting the Terre-Pex tail ends from water penetration and therefore maintain the physical properties over the life of the pipe.

Shrink Caps should be used whenever a connection is made between all and at the end of every tail end of Terre-Pex pipes and the situation or danger of water penetration is given. This typically includes all underground and outdoor applications.

1. Slide the sleeve over the carrier pipe and the jacket.

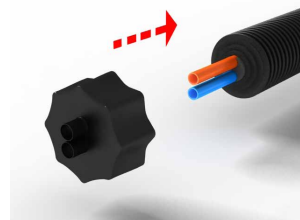

2. Use a heat gun or mini torch with soft yellow flame (do NOT use a blue flame!) to gently shrink the sleeve.

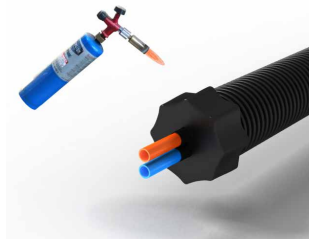

10

3. Press the sleeve, wearing protective gloves. The tail end of the pipe is now sealed watertight.

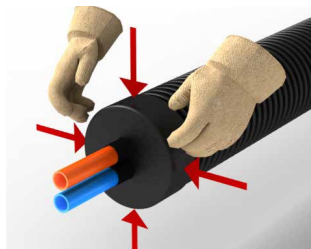

## Heatshrinkable Tubular Sleeve



Description	Part #
90mm & 110mm Shrink Sleeve 225mm long	SSL90/110
140mm & 160mm Shrink Sleeve 225mm long	SSL140/160
200mm & 225mm Shrink Sleeve 225mm long	SSL200/225

Locate defective spot on the pipe.

Make sure the jacket of the pipe is dry and clean.

Wrap the repair tape around the damaged jacket, overlapping each preceding layer by about 2 3/4".

Use a heat gun or mini torch with soft yellow flame (do NOT use a blue flame!) to gently shrink the repair sleeve.

Press the sleeve, wearing protective gloves.

The damaged jacket is now sealed watertight.

## R series Cold-Hot applied Wrapping Tape

Terre-Pex SINGLE and DOUBLE pipe Shrink Sleeve for HDPE jacket repair. An easy to use way to seal small cuts or damages to the outer jacket. The Terre-Pex shrink sleeve provides leakage protection into the insulation layer.

Description	Part #
200mm wide 10mm long	RETAP-H
150mm wide 10mm long	RETAP-C

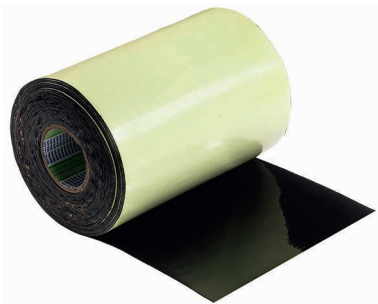

Locate defective spot on the pipe.

Make sure the jacket of the pipe is dry and clean.

Wrap the tape around the damaged jacket, overlapping each preceding layer by about 2 3/4" (press slightly).

Press firmly around the pipe jacket.

The damaged pipe jacket is now repaired.

This wall penetration sleeve consists of a corrugated jacket pipe and a shrink sleeve. Brick in the corrugated jacket as to just out about 4" from the wall.

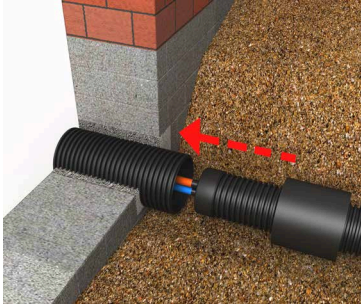

Description	Part #
90mm & 110mm Shrink Sleeve 225mm long	SSL90/110
140mm & 160mm Shrink Sleeve 225mm long	SSL140/160
200mm & 225mm Shrink Sleeve 225mm long	SSL200/225

Slide the shrink sleeve over the Terre-Pex pipe. NEVER CUT THE SLEEVE LENGTHWISE!

Push the Terre-Pex pipe through the bricked in corrugated jacket.



Use a heat gun or mini torch with soft yellow flame (do NOT use a blue flame!) to gently shrink the sleeve half onto the corrugated pipe and half onto the jacket of the Terre-Pex pipe.

The annular space between the Terre-Pex pipe and the wall opening must be filled carefully.

Press the sleeve, wearing protective gloves.

The wall penetration sleeve is ready now.



### 1. Pressure test and rinsing according to DIN 1988 Part 2

As evidence to the customer of the work carried out, section 3.1.13 of the new DIN 18581 relating to general technical specifications in contracts for construction works (ATV) envisages that, as one of the relevant accompanying documents, a log concerning the conducted pressure test should be issued and handed over to the customer. In this log which should be confirmed by the customer or his authorized representative, the plumber verifies that his work satisfies recognized engineering rules and the contractual obligations (as a secondary performance to be provided in accordance with VOB tendering and performance stipulations

### 2. Flushing the pipe system

For corrosion protection reasons the elaborate procedure of rinsing the system with an air/water mixture as described in DIN 1988 Part 2 need not be carried out. Coarse foreign particles can be removed simply by flushing the pipe system with water.

### 3. Pressure test procedure is obligatory

Prior to concealing, fill the finished pipe-work with water, taking care to avoid air bubbles. The pressure test must be conducted in two parts, starting with the preliminary test, followed by the main test.

#### Preliminary test

The preliminary test involves applying a test pressure equal to 1.5 times the admissible operating pressure. This pressure must be regenerated twice within the space of 30 minutes at intervals of 10 minutes. Following a test period of another 30 minutes, the test pressure must not have fallen by more than 9 psi (0.3 psi per minute). Leakages must not occur.

#### Main test

The main test has to be conducted immediately after the preliminary test. The test takes 2 hours. At the end of this period, the test pressure recorded after the preliminary test must not have fallen by more than 3 psi. Leakages must not occur at any point in the system being tested.

#### Remarks :

A further factor that may influence the test result can be caused by the temperature difference between the pipe and test medium caused by the high coefficient of thermal expansion of plastic pipes. A temperature change of 18°F corresponds approximately to a pressure change of 7 to 15 psi. For this reason, every effort should be made to ensure that the temperature of the test medium remains constant when carrying out pressure tests on system components made from plastic pipes.

In this context it is important to carry out a visual inspection of all joints while the pressure test is in progress since experience has shown that minor leakages cannot always be detected simply by monitoring a pressure gauge. Following the pressure test, the drinking water pipes must be flushed thoroughly.

A better approach to energy-efficient, insulated Pipes

